



● Thank you for purchasing the RX3 Meter. Before installing/operating the product, please read the instructions thoroughly and retain them for future reference.

**⚠ Attention! (For Motorcycle)**

1. For installation, please follow the steps described. Any damage caused by wrong installation shall be imputed to the users.
2. Do not disassemble or change any parts.
3. Opening the instrument will void any warranty. Maintenance or repair should be executed by our professionals only.

⊗ **SYMBOL DESCRIPTION:**

**NOTE** The symbols indicate additional instructions.

⚠ Some procedures must be followed to avoid damages to the instrument.

⚠ **WARNING!** Certain procedure must be followed to avoid damages to yourself, to the vehicle or others.



**1-1 Accessories**

<b>1</b> LCD Meter X1	<b>2</b> Main wiring harness X 1	<b>3</b> Active speed sensor X1	<b>4</b> RPM wire (Type A) X1
<b>5</b> RPM wire set (TYPE B) X1	<b>6</b> Sensor wire set X1	<b>7</b> Temperature sensor X1	<b>8</b> Meter external switch (Dual buttons type) X1
<b>9</b> Rubber strip X1	<b>10</b> M8 / S type speed sensor bracket X 1	<b>11</b> M10 / S type speed sensor bracket X 1	<b>12</b> M5x5xP0.8 Hexagon screw X 2
<b>13</b> 2.5 mm Allen key X 1	<b>14</b> 3 mm Allen key X1	<b>15</b> Meter bracket X1	<b>16</b> M4X12Lmm Screw X3
<b>17</b> M5 washer X3	<b>18</b> M6 X 35L Screw X2	<b>19</b> M8 X 30L Screw X2	<b>20</b> M6 Screw X2
<b>21</b> M8 Screw X2	<b>22</b> M6 Gasket X2	<b>23</b> M8 Gasket X2	

**NOTE** Contact your local distributor, if the items received in the box are not the same as the items listed above.

**1-2 Optinal accessories**

<b>1</b> L type speed sensor bracket BI003S01	<b>2</b> Oil temp sensor adapter M12 X P1.5 X 15L M14 X P1.25 X 15L M14 X P1.5 X 15L M18 X P1.5 X 15L M18 X P1.5 X 15L M20 X P1.0 X 15L M20 X P1.5 X 15L BG*****	<b>3</b> Water temp sensor adapter M14 M16. M18 M22. M26 mm BG*****	<b>4</b> Signal connect wire 20-c94300a
<b>5</b> Oxygen sensor X 1 (WALKER, SMG) 28-bk00210	<b>6</b> Sensor bung bf003r000e	<b>7</b> Screw cap ba550r020e	

**NOTE** Some of the option accessories may be purchase separately. For more details, please contact your local distributor.

**2-1 Wiring Installation Instructions**

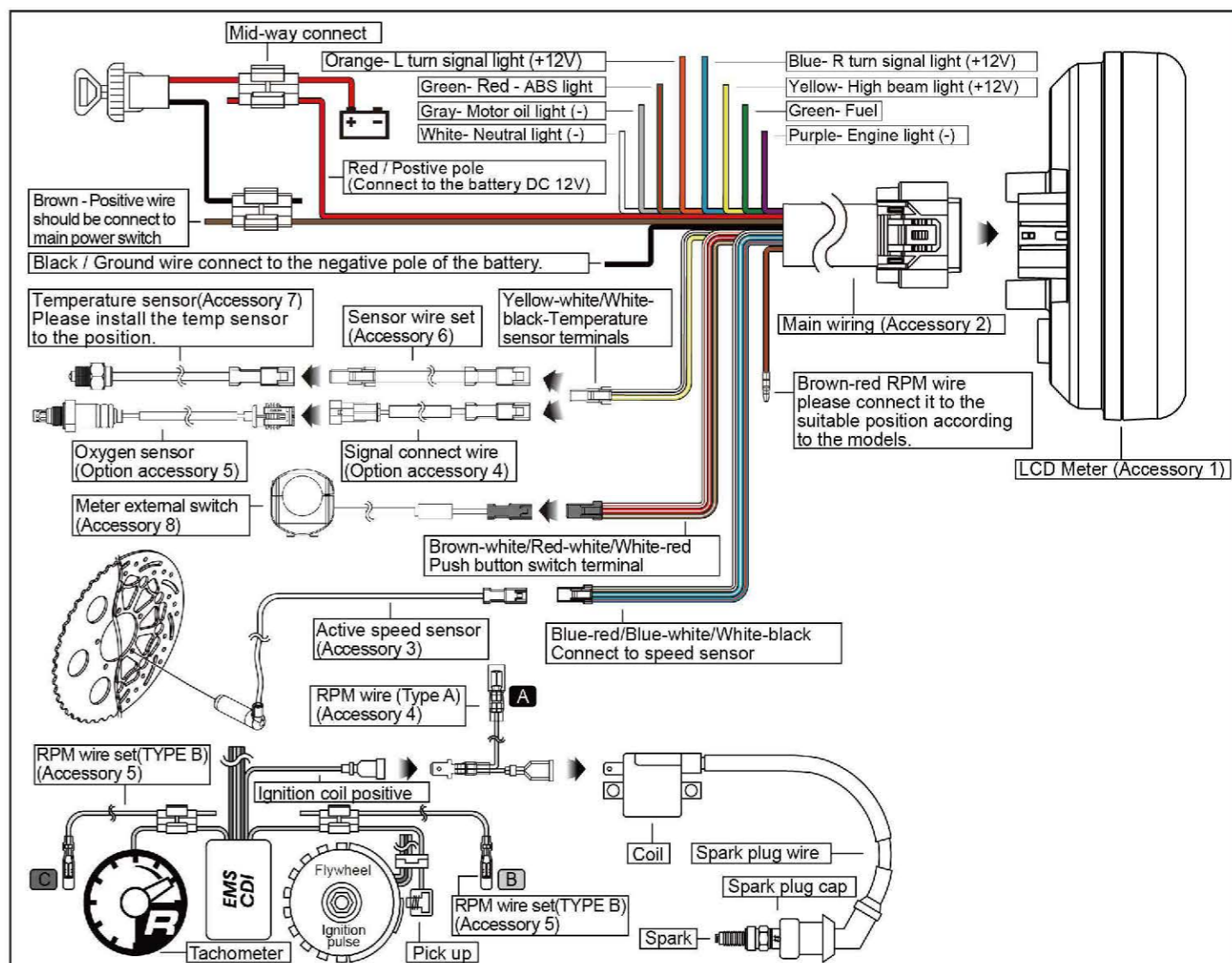

⚠ The fuel sensor is electronic type, please don't parallel connection with the original- otherwise the fuel gauge won't display. The wrong installation of the fuel wiring may cause the meter break.

**NOTE** When connecting the power wire, please follow carefully the instructions. If the red & brown wires are connected in parallel, the meter won't work properly.

⚠ The RPM wire installation  
We recommend installing the R type spark plug or low-resistance spark plug cap at the same time.  
A. Connect the RPM wire (Type A) on the spark plug wire by connecting the male and female connectors.  
B. Connect the RPM wire (Type B) to the pick up sensor.  
C. Connect in parallel the RPM wire (Type A) with the original tachometer signal wire.  
**The best signal source will be in order as C>B>A, we will suggest that you check different ways if you have problems getting the RPM signal.**

## 2-2 Installation instructions

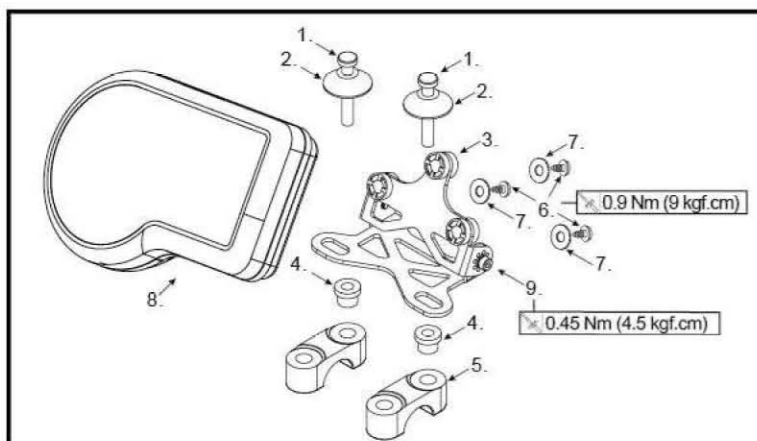

### Follow the steps below during installation.

1. M6 or M8 Screw X2 (Accessory 18,19)
2. M6 or M8 Screw X2 (Accessory 20,21)
3. Meter bracket (Accessory 15)
4. M6 or M8 Gasket X2 (Accessory 22,23)
5. Handle bar bracket

**NOTE** You can also install it (meter bracket) on the original meter bracket.

6. M4 screw X 3 (Accessory 16)
7. M5 washer X3 (Accessory 17)
8. LCD Meter (Accessory 1)
9. Meter bracket micro-adjustment screw

**NOTE** You can choose the angle first and then use the screw to fix the angle.

**NOTE** The handle bar bracket screw and screw hole will differ depending on the model. We suggest you to use the additional assembly (item 1.2.4) to fit it.

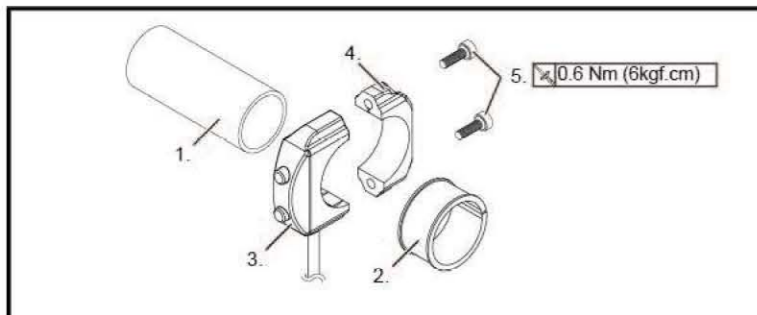

### Follow the steps below during installation.

1. Handle bar
2. Rubber strip (Accessory 9)
3. Meter external switch (Dual buttons type)-Upper case (Accessory 8)
4. Meter external switch (Dual buttons type)-Bottom case (Accessory 8)
5. M3x12xP0.5 mm screw

**CAUTION!** Total length of wiring is 600 mm. Please pay attention to the distance between the wire exit hole and the end of handlebar to avoid the occurrence of insufficient wire length.

**NOTE** Do not need the Rubber strip (Accessory 9) if the handle bar is 1 inch.

## 2-3 Oxygen Sensor Installation

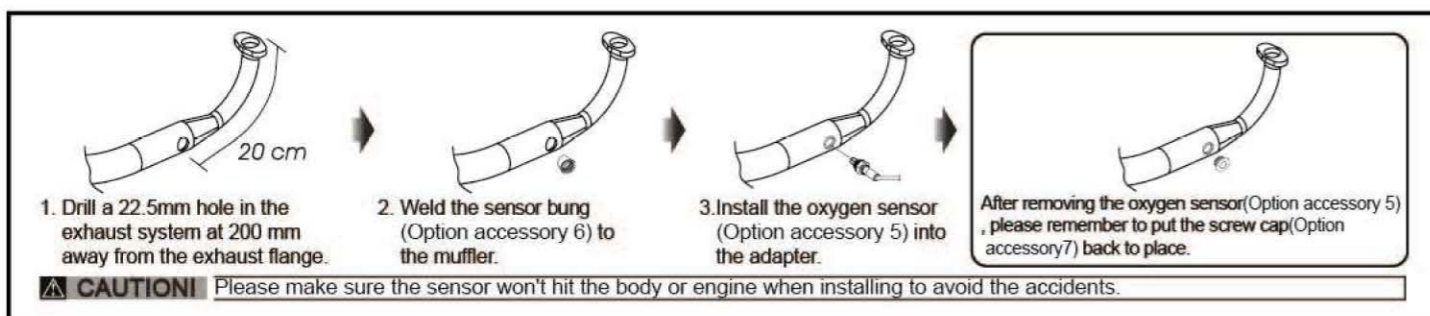

## MOTO / SCOOTER S type speed sensor bracket instruction

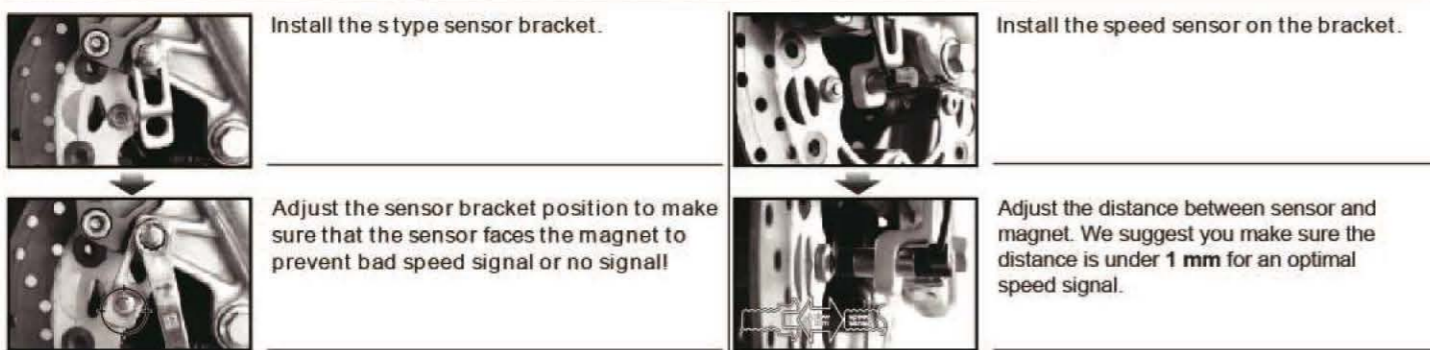

**PS.** The active speed sensor can be facing the metal parts to detect the speed.

EX. 1 The disc screw.  
EX. 2 The disc to detect the disc gap. (Please make sure the distances between the gaps are the same in advance to avoid wrong speed signal.)  
EX. 3 The sprocket to detect the disc gap. (Please make sure the distances between the gaps are the same in advance to avoid wrong speed signal.)  
EX. 4 Rear disc - detect the gap between the disc.  
**We will suggest you to catch the speed from the disc screws. The more the sensor points are, the better the speed accuracy is. The maximum sensor points the speed sensor could detect is 40 points per turn.**

**After installation, please use your hand to turn the tire to see if everything is ok. The LED on the active speed sensor will light up once the signal is detected.**

**EX. 1**

**The hexagon socket disc screw**  
The best detect area: The edge of the hexagon socket screw.  
**CAUTION!** Please don't pick-up the signal from the middle hole of the hexagon socket screw to avoid wrong signal.

**EX. 2**

**The hexagon screw**  
The best detect area: The middle of the screws.  
**CAUTION!** Some hexagon screw center is with a small hole in the center in this case, we will suggest you to catch the signal from the edge of the screw like the hexagon socket screw.

**EX. 2.4**

**The disc**  
The best detection area: Please detect the speed signal from the gaps of the disc.  
**CAUTION!** Please note that there are discs with the gaps in different difference, and this method will not work on it!

**EX. 3**

**The sprocket**  
The best detect area: Please detect the speed signal from the gaps of the sprocket.  
**CAUTION!** Please note that there are sprockets with the gaps in different difference, and this method will not work on it!

## 3-1 Meter Size

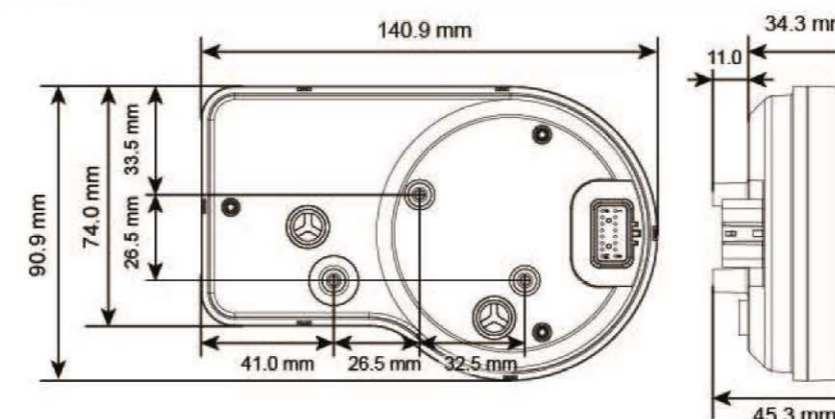

## 3-2 Basic Function Instruction

**Fuel warning setting**

- Setting range : 0 ~ 3/6
- Setting unit : 1

**Voltage warning**

- Setting range : DC 8.0 ~ 18.0 V
- Setting unit : DC 0.1 V

**Motor oil maintenance**

- Setting range : 500 ~ 16,000 km(300~10,000 mile), OFF
- Setting unit : 100 km(mile)

**Speeding warning setting**

- Setting range : 30~360 km/h (20~225 MPH)
- Setting unit : 1 km/h (MPH)

**Overheat warning setting**

- Setting range : 60 ~ 250 °C (140 ~ 482 °F)
- Setting unit : 1 °C (°F)

**Shift light warning setting**

- Setting range : 1,000 ~ 15,000 RPM
- Setting unit : 100 RPM

**Tachometer**

- Display range : 0~15,000 RPM

**Indicator**

- Warning light (Red)
- indication light (Green)
- High beam light (Blue)
- Neutral light (Green)
- Engine light (Amber)
- Motor oil light (Red)
- ABS light (Amber)

**Gear Meter**

- Display range : -, N, 1~the highest gear (the highest gear shall be based on the gear learning)

**Fuel meter**

- Display range : 6 levels

**Speedometer**

- Display range : 0 ~ 360 km/h (0 ~ 225MPH)
- Display unit : 1 km/h (MPH)Switchable

**Clock**

- Display range : 00:00 ~ 23:59 (24H), 1:00 ~ 12:59 (12H)

**Thermometer**

- Display unit : °C and °F Switchable
- Display range : 0 ~ 250 °C(32 ~ 482 °F)
- Display unit : 0.1°C (°F)

**A/F ratio meter**

- Display range : 12.1~17.5
- Display unit : 0.1

**Voltmeter**

- Display range : DC 8.0~18.0 V
- Display unit : DC 0.1 V

**Odometer**

- Display range : 0~999,999 km (mile)and then return to zero
- Display unit : 1 km (mile)

**Motor oil maintenance**

- Display range : 500~16,000 km (300~10,000 mile)(user adjustable)~999 km(mile)
- Display unit : 1 km (mile)

**Trip meter A, B**

- Display range : 0.0~9,999.9 km (mile)may return to zero manually
- Display unit : 0.1 km (mile)

### 3-3 Specifications(Meter)

●Speedometer	Display range : 0 ~ 360 km/h (0 ~ 225 MPH) Display unit : 1 km/h (MPH) Switchable	○Fuel warning setting	Setting range : 0 ~ 3/6, when setting value is reach or below, warning light will lit. Setting unit : 1
○Odometer	Display range : 0 ~ 999,999 km (mile)and then return to zero Display unit : 1 km (mile)	●Clock	Setting range : 00:00~23:59 (24H) 01:00~12:59 (12H)
○Trip meter A, B	Display range : 0~9,999.9 km (mile), may return to zero manually Setting unit : 0.1 km (mile)	●Voltmeter	Display range : DC 8.0 ~ 18.0 V Display unit : DC 0.1 V
○Motor oil maintenance	Setting range : 500 ~ 16,000 km(300~10,000 mile),OFF Setting unit : 100 km(mile)	○Low voltage warning	Setting range : DC 8.0~13.0 V, when setting value is reach or below, warning light will lit. Setting unit : DC 0.1 V
○Speeding warning setting	Setting range : 30~360 km/h (20~225 MPH), when setting value is reach or above, warning light will lit. Setting unit : 1 km/h (MPH)	○High voltage warning	Setting range : DC 13.1~18.0 V, when setting value is reach or above, warning light will lit. Setting unit : DC 0.1 V
○Max. speed record	Display range : 0 ~ 360 km/h (0 ~ 225 MPH) Display unit : 1 km/h (MPH)	●Target speed	Setting range : 30 ~ 360 km/h (20 ~ 225 MPH) Setting unit : 5 km/h (MPH)
○Circumference	Setting range : 300~2,500 mm Setting unit : 1 mm	●Target distance	Setting range : 50 ~ 1,500 m (1/32 ~ 30/32 mile) Setting unit : 50 m (1/32 mile)
○Sensitive point	Setting range : 1~40 P Setting unit : 1 P	●Top speed	Display range Speed : 0 ~ 360 km/h (0 ~ 225 MPH) Distance : 0 ~ 999 m (0~3,280 feet) Rotating speed : 0 ~ 15,000 RPM Time : 0 ~ 9 : 59'99"
●Gear Meter(Learning)	Display range : -, N, 1~the highest gear, (the highest gear shall be based on the gear learning)	●Background display	Setting range : Auto(automatically switch according to the light : day mode display for the bright environment and Night mode display for the dark environment), Day mode, Night mode.
○Max. Gear record	Display range : -, N, 1~the highest gear (the highest gear shall be based on the gear learning)	○Back light brightness (Day)	Setting range : 3/5~ 5/5(Brightest) Setting unit : 1/5
●Tachometer	Display range : 0~15,000 RPM	○Back light brightness (Night)	Setting range : 1/5(Darkest) ~ 5/5(Brightest) Setting unit : 1/5
○Shift light warning setting	Display range : Steady, Fast Flash Setting range : 1,000~15,000 RPM Setting unit : 100 RPM	○Back light color	Setting range : white, red, orange,green,blue, Loop switch
○Max. rotating speed	Display range : 0~15,000 RPM (At the MAX screen, the pointer shows the highest speed recorded so far.)	●Unit	Speed unit : km/h , MPH Temperature unit : °C (Celsius) and °F (Fahrenheit)
○The RPM input signal number setting	0.5,1.0~24.0	●Voltage	DC 12 V
○The RPM input pulse	Setting range : Low-Act, High-Act	●Operating temperature	-10 ~ +60 °C
●Thermometer	Display range : 0 ~ 250.0 °C (32.0 ~ 482.0 °F) Display unit : 0.1 °C (°F)	●Specification	JIS D 0203 (S2)
○Overheat warning setting	Setting range : 60 ~ 250 °C (140 ~ 482 °F), when setting value is reach or above, warning light will lit. Setting unit : 1 °C (°F)	●Meter Size	140.9 x 90.9 x 45.3 mm
○Max. temperature record	Display range : 0 ~ 250 °C (32.0 ~ 482 °F)	●Meter Weight	Around 188 g
●A/F ratio meter	Display range : 12.1~17.5 Display unit : 0.1	●Indicator	Indication light (Green) High beam light (Blue) Neutral light (Green) Engine light (Amber) Motor oil light (Red) ABS light (Amber)
●Fuel meter	Display range : 6 levels Display unit : 1 level(16.6 %) Setting range : 100 Ω, 250 Ω, 270 Ω,390 Ω, 510 Ω, 1200 Ω, SW, learning mode,OFF	○Composite warning light	OFF, Fast Flash,Steady, Slow Flash/(Red)
		○Over-running light + light sensing	Fast Flash, Steady/(Red)

**NOTE** Design and specifications are subject to change without notice!

### 3-4 Size,Specifications(Meter External Switch)

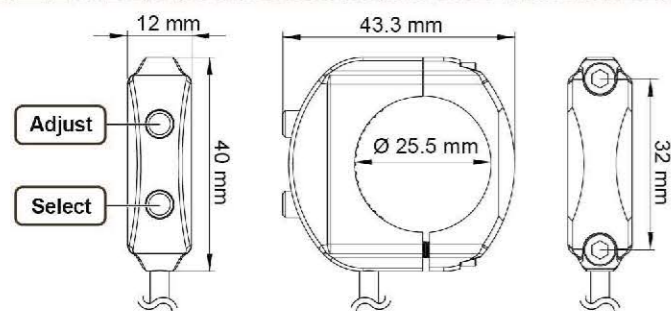

●Effective temperature range	-10 ~ 60 °C
●Standard	JIS D 0203
●Effective voltage	MAX DC 30V / Max. 50 mA / 1.6W
●Size	About 43.3 x 40 x 12 mm
●Weight	About 36 g

**NOTE** Meter external switch (Accessory 8) is suitable for 7/8 & 1 inch handlebar.

**NOTE** Design and specifications are subject to change without notice!

### 3-5 Buttons Function Description

●Press the Adjust button.  
Record Screen→Switch to Target speed, Target distance, and Top speed in a cycle.  
Setting Screen→Switch to setting function.  
Setting function screen→Increase the value in a cycle.

●Press the Adjust button for 3 seconds.  
Main screen→1. Enter the fast setting for Clock and Backlight.  
2. Return to the main screen from fast setting.  
Record Screen→Enter the fast setting for Target distance, Target speed and Top speed.  
Setting screen→Switch to the startup screen.

●Press and hold the Adjust button.  
Setting function screen→Accumulate the value, switch options in a cycle.

●Press the Select button.  
Main screen→Switch to ODO, TRIP A, TRIP B, TRIP O, and MAX in a cycle.  
Record Screen→Enter the testing screen.  
Setting Screen→Switch to setting function.  
Setting function screen→Confirm selection and switch to the next functional option on the same page in a cycle.

●Press the Select button for 3 seconds.  
Main screen→Individually clear or reset TRIP A, TRIP B, TRIP O, or MAX records.  
Record Screen→Individually clear Target distance, Target speed, or Top speed records.  
Checking Screen→Enter the MAX. record clear screen.  
Setting Screen→Enter the setting function screen.  
Setting function screen→Go back to the setting screen.

●Press the Adjust + Select buttons.  
Main screen→Switch to record screen.  
Record Screen→Switch to checking screen.  
Checking Screen→Switch to main screen.

●Press the Adjust + Select buttons for 3 seconds.  
Main screen→Switch to setting screen.  
Record Screen→Switch to setting screen.  
Checking Screen→Switch to setting screen.

### 4 Startup Screen Switching Description

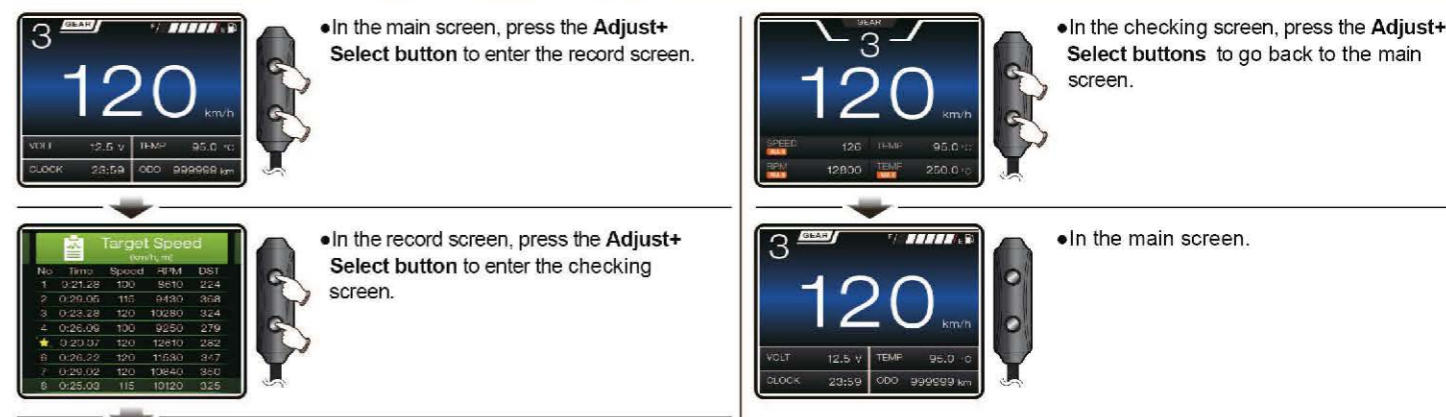

### 4-1 Main Menu Switching Description

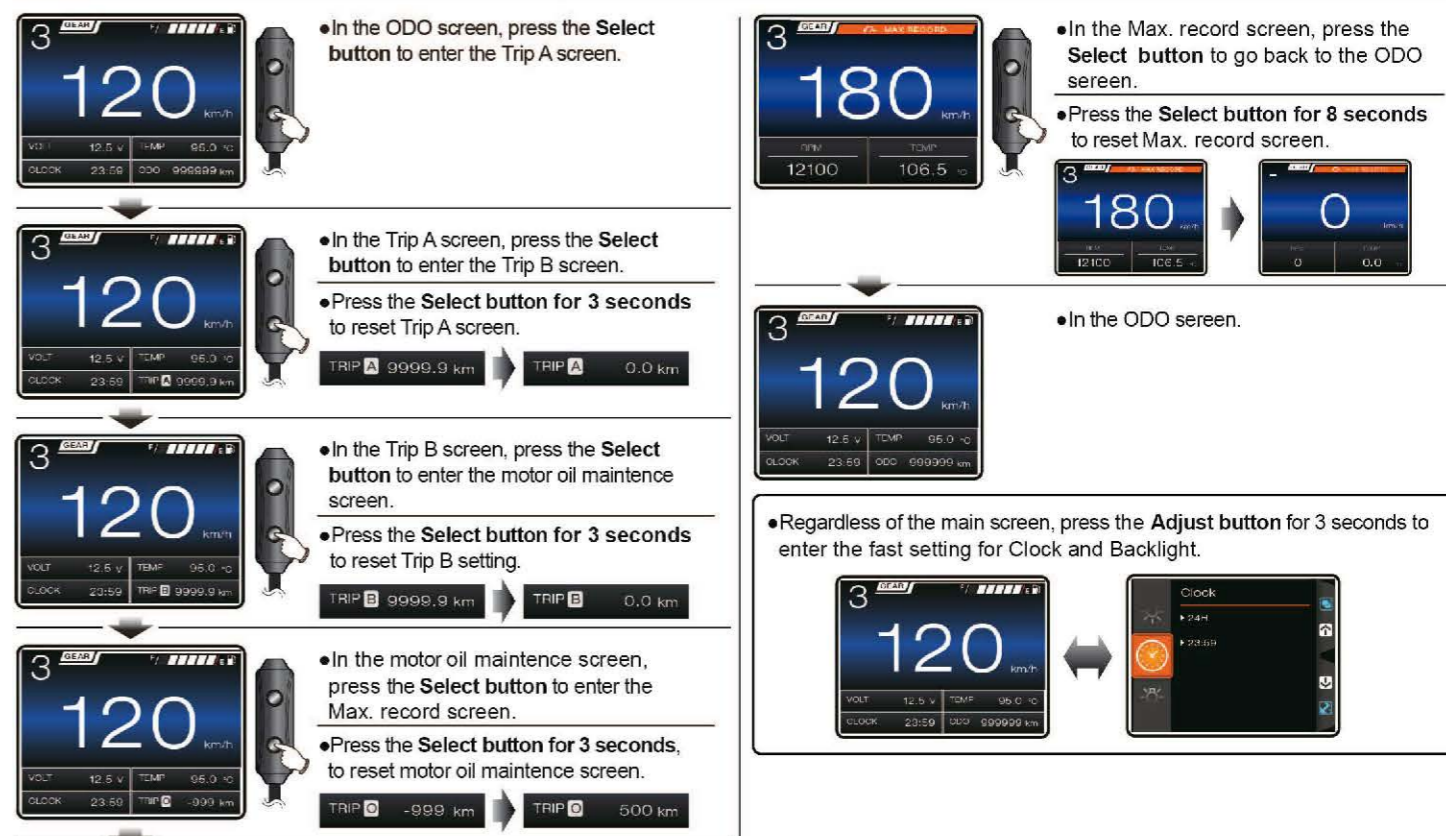

### 4-2 Record Screen Switching Description(Target Speed, Target Distance, Top Speed)

• In the main screen, press the **Adjust+Select** button to enter the target speed record screen.

• In the top speed record screen, press the **Adjust +Select** button to enter the checking screen.

• In the target speed record screen, press the **Adjust** button to enter the target distance record screen.

• In the checking screen.

• In the target distance record screen, press the **Adjust** button to enter the top speed record screen.

• Regardless of the record screen, press the **Adjust** button for **3 seconds** to enter the Power Test fast setting.

### 4-2-1 Description Of Target Speed Test

• In the target speed record screen, press the **Select** button to enter the testing screen.  
**NOTE** Start the test when the bike is fully stopped.

• When you reach the target speed that you set (0~110 km/h), the timer will stop (19'20 second).

• In the testing screen.  
**WARNING!** Use this function on racetracks to avoid accidents.

• When speed decreases to 0 km/h (MPH), the target speed record screen will appear.

• When the bike moves, the timer will start automatically.  
**NOTE** The timer is automatic, so when your bike starts to move the timer will start to calculate the time and stop automatically when you stop the bike.

• In the target speed record screen.  
• Press the **Select** button for **3 seconds**, to reset the target speed record.

• Speed up.

• Press the **Adjust** button to cancel deletion.  
• Press the **Select** button to confirm deletion.

### 4-2-2 Description Of Target Distance Test

• In the target distance record screen, press the **Select** button to enter the testing screen.  
**NOTE** Start the test when the bike is fully stopped.

• When the bike moves, the timer will start automatically.  
**NOTE** The product adopts digital sensing; when the vehicle starts, the timer would immediately start measuring. Upon achieving the target distance, the timer would immediately stop measuring.

• In the testing screen.  
**WARNING!** Use this function on racetracks to avoid accidents.

• Speed up.

• When you reach the target distance that you set (100 M . 2/32 mile), the timer will stop (12'27 second).

• In the target distance record screen.  
• Press the **Select** button for 3 seconds, to reset the target distance record.

• When speed decreases to 0 km/h (MPH), the target distance record screen will appear.

• Press the **Adjust** button to cancel deletion.  
• Press the **Select** button to confirm deletion.

### 4-2-3 Description Of Top Speed Test

• In the top speed record screen, press the **Select** button to enter the testing screen.  
**NOTE** Start the test when the bike is fully stopped.

• When you reach the top speed (100 km/h), the meter will stop counting the distance (510 m), and time (25'65 seconds).

• In the testing screen.  
**WARNING!** Use this function on racetracks to avoid accidents.

• When speed decreases to 0 km/h (MPH), the top speed record screen will appear.

• When the bike moves, the timer will start automatically.  
**NOTE** Display range(Top speed) : Speed : 0 ~ 360 km/h (0 ~ 225 MPH)  
Distance : 0 ~ 999 m (0~3,280 feet)  
Rotating speed : 0 ~ 15,000 RPM  
Time : 0 ~ 9'59'99

• In the top speed record screen.  
• Press the **Select** button for **3 seconds**, to reset the top speed record.

• Speed up.  
**NOTE** The product adopts digital sensing; when the vehicle starts, the odometer and the timer would immediately start measuring. Upon achieving the maximum speed, the odometer and the timer would immediately stop measuring.  
**WARNING!** The speed unit of the function would change according to 5-2 Change in Speed Unit.

• Press the **Adjust** button to cancel deletion.  
• Press the **Select** button to confirm deletion.

### 4-3 Checking Screen Switching Description

• In the main screen, press the **Adjust+Select** buttons for **2 times** to enter the checking screen.

• In the main screen.

• In the checking screen, press the **Adjust+Select** buttons to go back to the main screen.  
• Press the **Select** button for **3 seconds** to clear all MAX. record.

## 5 Setting Screen Switching Description

- Press the **Adjust + Select** buttons for 3 seconds on the main screen, record screen, or checking screen to switch to the setting screen.
- Press the **Adjust** button or **Select** button to select
- 1 Clock 2 Unit(Speed/Temperature) 3 Backlight(Mode/Brightness/Color) 4 Speeding warning 5 Shift light warning
- 6 Overheat warning 7 Voltage warning 8 Fuel warning 9 Motor oil maintenance 10 ABS warning 11 Warning light warning
- 12 Tire circumference(Sensing point) 13 Gear 14 RPM input pulse / signal impulse 15 Fuel resistance
- 16 A/F ratio 17 POWER TEST 18 Internal and External ODO and etc.
- Press the **Select** button for 3 seconds to enter the setting function screen.
- In the setting screen, press the **Adjust** button for 3 seconds to switch to the startup screen.

**NOTE** During setting, if button is not pressed in 3 minutes, it will automatically return to the startup screen.



### 5-1 Clock Setting

- The Clock screen, press the **Select** button for 3 seconds to enter the clock setting.
- **Example : To set clock(minute) as 10 minutes.**  
• Press the **Select** button to move to the digit you want to set.  
**NOTE** Setting range : 00~59 minutes. Default value : 0.
- Press the **Adjust** button to choose the setting number.
- **Example : Changing the 12H.**  
• Press the **Adjust** button to choose the setting number.  
**NOTE** Setting range : 12 H, 24 H. Default value : 24 H.
- EX : Set time format from 24 H to 12 H.  
• Press the **Select** button to enter time adjustment hour setting.
- **Example : To set clock(hour) as 10 hours.**  
• Press the **Adjust** button to choose the setting number.  
**NOTE** Cursor moving order is : Hour → Digit in ten minutes → Digit in minutes  
**NOTE** Setting range : 1~12(12H) 0~23(24H) Default value : 12(12H)/0(24H)
- EX : Set hour from 12:00 AM to 10:00 PM.  
• Press the **Select** button to enter clock adjustment minute setting.
- The Clock screen.

### 5-2 Unit (Speed, Temperature) Setting

- The unit screen, press the **Select** button for 3 seconds to enter the speed unit setting.
- **Example : To set temp. unit to °F.**  
• Press the **Adjust** button to choose the setting options.  
**NOTE** Setting range : °C (Celsius) and °F (Fahrenheit). Default value : °C (Celsius).
- EX : Set temp. unit from °C (Celsius) to °F (Fahrenheit).  
• Press the **Select** button to go back to the unit (speed, temp.) screen.
- The unit (speed, temp.) screen.
- **Example : To set speed unit as MPH.**  
• Press the **Adjust** button to choose the setting options.  
**NOTE** Setting range : km/h, MPH. Default value : km/h.
- EX : Set speed unit from km/h to MPH.  
• Press the **Select** button to enter the temp. unit setting screen.

### 5-3 Backlight Setting(Mode/Brightness/Color)



- The backlight screen, press the **Select** button for 3 seconds to enter the background mode setting.



- Example : To set the mode to Night mode.
- Press the **Adjust** button to choose the setting options.
- ⚠ Now the setting value is flashing!
- NOTE** Setting Auto(automatically switch according to the light : day mode display for the bright environment and Night mode display for the dark environment), Day mode, Night mode.  
Default value : Auto.



- EX : Set background from Auto mode to Night mode.
- Press the **Select** button to enter the backlight brightness (day) setting.



- Example : To set the backlight brightness (day) at 4(80%).
- Press the **Adjust** button to choose the setting number.
- ⚠ Now the setting value is flashing!
- NOTE** Setting range : 3~ 5 (Brightest).  
Setting unit : 20% per level.  
Default value : 5(100%).
- NOTE** The backlight brightness will change immediately after you set the value.



- EX : The backlight brightness (day) setting is changed from 5 (100%) to 4 (80%).
- Press the **Select** button to enter the backlight brightness (night) setting.



- Example : To set the backlight brightness (night) at 2(40%).
- Press the **Adjust** button to choose the setting number.
- ⚠ Now the setting value is flashing!
- NOTE** Setting range : 1 (Darkest) ~ 5 (Brightest), 5 different levels available.  
Setting unit : 20% per level.  
Default value : 3(60%).
- NOTE** The backlight brightness will change immediately after you set the value.



- EX : The backlight brightness (night) setting is changed from 3 (60%) to 2 (40%).
- Press the **Select** button to enter the backlight color setting.



- Example : To set backlight color to blue.
- Press the **Adjust** button to choose the color.
- ⚠ Now the setting value is flashing!
- NOTE** Switch color according to the following order, white, red, orange, green, blue.
- NOTE** Default value : White.
- NOTE** The backlight color will change immediately after you set the value.



- EX : Set backlight color from white to blue.
- Press the **Select** button to go back to the backlight screen.



- The backlight screen.

### 5-4 Speeding Warning Setting



- From the backlight screen, press the **Select** button for 3 seconds to enter the speeding warnin setting.



- Example : To set speeding warning value to 80 KPH.
- Press the **Select** button to move to the digit you want to set.
- ⚠ Now the setting value is flashing!
- NOTE** Setting range : 30~360 km/h (20~225 MPH).  
Default value : 60 km/h (38 MPH).



- Press the **Adjust** button to choose the setting number.



- EX : Set speed warning value from 60 KPH to 80 KPH.
- Press the **Select** button to go back to the speed warning screen.



- The speed warning screen.

### 5-5 Shift Light Warning Setting



- The shift light warning screen, press the **Select** button for 3 seconds to enter the shift light warning(Steady) setting.



- Example : To set shift light warning (Steady) value to 12,000 RPM.
- Press the **Select** button to move to the digit you want to set.
- ⚠ Now the setting value is flashing!
- NOTE** Setting range : 1,000~15,000 RPM.  
Default value : 9,000 RPM.



- Press the **Adjust** button to choose the setting number.



- EX : Set shift light warning(Steady) value from 9,000 RPM to 12,000 RPM.
- Press the **Select** button to enter the shift light warning(Fast Flash) setting.



- Example : To set shift light warning (Fast Flash) value to 11,000 RPM.
- Press the **Select** button to move to the digit you want to set.
- ⚠ Now the setting value is flashing!
- NOTE** Setting range : 1,000~15,000 RPM.  
Default value : 8,000 RPM.
- ⚠ It will flash when it reaches the shift light value.



- Press the **Adjust** button to choose the setting number.



- EX : Set shift light warning(Fast Flash) value from 8,000 RPM to 11,000 RPM.
- Press the **Select** button to go back to the shift light warning screen.



- The shift light warning screen.

### 5-6 Overheat Warning Setting



- The overheat warning screen, press the **Select** button for 3 seconds to enter the overheat warning setting.



- Example : To set overheat warning value to 120 °C.
- Press the **Select** button to move to the digit you want to set.
- ⚠ Now the setting value is flashing!
- NOTE** Setting range : 60 ~250 °C (140 ~482 °F).  
Default value : 90 °C(194 °F).



- Press the **Adjust** button to choose the setting number.



- EX : Set overheat warning value from 90 °C to 120 °C.
- Press the **Select** button to go back to the overheat warning setting.



- The overheat warning screen.

### 5-7 Voltage Warning Setting

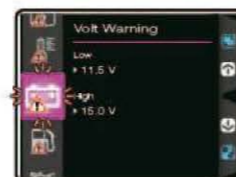

- The voltage warning screen, press the **Select** button for 3 seconds to enter the low voltage warning setting.



- Example : To set low voltage warning value to DC 11.0 V.
- Press the **Adjust** button to choose the setting number.
- ⚠ Now the setting value is flashing!
- NOTE** Setting range : DC 8.0~13.0 V.  
Default value : DC 11.5 V.



- EX : Set low voltage warning value from DC 11.5 V to DC 11.0 V.
- Press the **Select** button to enter the high voltage warning setting.



- EX : Set high voltage warning value from DC 15.0 V to DC 16.0 V.
- Press the **Select** button to go back to the voltage warning screen.

### 5-8 Low Fuel Warning Setting



- The low fuel warning screen, press the **Select** button for 3 seconds to enter the low fuel warning setting.



- EX : Set low fuel warning value from 1/6 to 3/6.
- Press the **Select** button to go back to the low fuel warning screen.

### 5-9 Motor Oil Maintenance Setting



- The motor oil maintenance screen, press the **Select** button for 3 seconds to enter the motor oil maintenance setting.



- Press the **Adjust** button to choose the setting number.



- Press the **Adjust** button, and select whether to turn on the motor oil maintenance function.
- Select ON to enter the motor oil maintenance setting.



- EX : The motor oil maintenance setting is changed from 500 km to 1,200 km.
- Press the **Select** button to go back to the motor oil maintenance screen.

### 5-10 ABS Warning Setting



- The ABS warning screen, press the **Select** button for 3 seconds to enter the ABS warning setting.



- Press the **Adjust** button, and select whether to turn on the ABS warning function.



- Press the **Select** button to go back to the ABS warning screen.



- The ABS warning screen.

### 5-11 Warning Light Warning Setting



- The warning light warning screen, press the **Select** button for 3 seconds to enter the warning light warning setting.



- Press the **Select** button to go back to the warning light warning screen.

### 5-12 Tire Circumference and sensing point setting



- The tire circumference and sensing point screen, press the **Select** button for 3 seconds to enter the tire circumference and sensing point setting.



- Press the **Adjust** button to choose the setting number.

**PS.** You can use the tire valve as the starting point and the terminal point to measure the wheel circumference with a measuring tape.





- EX : Set the sensor point value from 01 P to 06 P.
- Press the **Select** button to enter the learning mode setting.



- Press the **Adjust** button to start the learning mode.



- Please ride for 1 km(1 mile); after the arrival, press the **Select** button for 3 seconds. Complete learning by return to the tire circumference and sensing point screen.
- Press the **Adjust** button for 3 seconds to cancel learning.

**NOTE** When mile is set for the unit, please ride for 1 mile.



- The tire circumference and sensing point screen.

**5-13 Gear Setting**



- The gear screen, press the **Select** button for 3 seconds to enter the gear setting.



- Example : You want to set the gear setting to ON.
- Press the **Adjust** button to choose the setting options.

**NOTE** Now the setting value is flashing!

**NOTE** Setting range : ON, OFF. Default value : ON.

**NOTE** Select OFF to return to the gear screen.



- EX : Set the gear setting to ON.
- Press the **Select** button to enter the gear-learning setting screen.



- Press the **Adjust** button to start the gear-learning setting.

**NOTE** Enter the Learning Mode, and learn the Gear position according to the speed and RPM.



- In the gear-learning setting.

**CAUTION!** Before setting, be sure to put your motor in Neutral to avoid error detection.

**CAUTION!** "Fail" on the screen means error detection, please re-set Gear-Learn.

**CAUTION!** If gear learning is not required, press **Adjust** and hold for 3 seconds to cancel the gear learning.

- When N→1 appears, please change to Gear 1 to ride. When Gear 1 is detected, 1→2 appears and then change to Gear 2.



- 1 → 2 ○Please change to Gear 2.
- 2 → 3 ○Please change to Gear 3.
- 3 → 4 ○Please change to Gear 4.
- 4 → 5 ○Please change to Gear 5.
- 5 → 6 ○Please change to Gear 6.



- After reaching and finishing Gear 6, please wait for a few seconds to end gear-learning and return to the gear screen.



- The gear screen.

**5-14 RPM Input Pulse & Signal Impulse**



- The RPM input pulse & signal impulse screen, press the **Select** button for 3 seconds to enter the RPM input pulse & signal impulse setting.

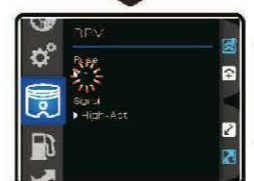

- Example : You want to set the RPM input pulse to 2 (4 Stroke, 4 piston).
- Press the **Adjust** button to choose the setting number.

**NOTE** Now the setting value is flashing!

**NOTE** Setting range : P-0.5, 1.0~24.0. Default value : 1.0.

The setting value	The corresponding stroke and pistons number.	The corresponding RPM signal number per ignition.
0.5	4C-1P	2 RPM signals per 1 ignition.
1.0	2C-1P / 4C-2P	1 RPM signal per 1 ignition.
2.0	2C-2P / 4C-4P	1 RPM signal per 2 ignition.
3.0	2C-3P / 4C-6P	1 RPM signal per 3 ignition.
4.0	2C-4P / 4C-8P	1 RPM signal per 4 ignition.
5.0	4C-10P	1 RPM signal per 5 ignition.
6.0	2C-6P / 4C-12P	1 RPM signal per 6 ignition.

**CAUTION!** Most of the 4-cycle bikes with one single piston are igniting once every 360 degree, so the setting should be the same as the bike with 2-cycle and one piston engine.



- EX : The RPM input pulse setting is changed from 1.0 to 2.0.
- Press the **Select** button to enter the signal impulse setting.



- Example : Set the signal impulse to Low-Act.
- Press the **Adjust** button to choose the setting options.

**NOTE** Now the setting value is flashing!

**NOTE** Setting range : High-Act, Low-Act. Default value : High-Act.



- EX : Set the signal impulse from High-Act to Low-Act.
- Press the **Select** button to go back to the RPM input pulse & signal impulse screen.



- The RPM input pulse & signal impulse screen.

**5-15 Fuel Gauge Resistance Setting(Ω)**



- The fuel gauge resistance screen, press the **Select** button for 3 seconds to enter the fuel gauge resistance setting.

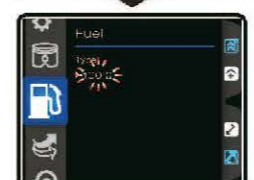

- Example : To set the fuel gauge resistance value as 100 Ω.
- Press the **Adjust** button to choose the setting number.

**NOTE** Now the setting value is flashing!

**NOTE** Setting range : 100 Ω, 250 Ω, 270 Ω, 390 Ω, 510 Ω, 1200 Ω, SW, Custom, OFF. Default value : 100 Ω.

**NOTE** Custom fuel level resistance:  
 1) Manual - Please check 5-15-1 Fuel Level Resistance Manual Setting Instructions.  
 2) Auto - Please check 5-15-2 Fuel Level Resistance Auto Setting Instructions.

**NOTE** If the fuel sensor wire is not plugged in, fuel level will display error.



- EX : Set fuel gauge resistance value to 100 Ω.
- Press the **Select** button to go back to the fuel gauge resistance screen.



- The fuel gauge resistance screen.



### 5-15-1 Fuel Gauge Resistance Setting (Manual)

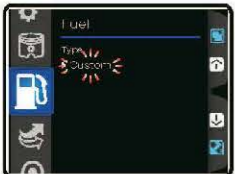

- Press the **Select** button to enter the fuel gauge resistance setting (manual).
- Example : For YAMAHA T-MAX 530, according to the service manual, the fuel tank resistance from low to high is 90 - 100 Ω (the lowest) and 4 - 10 Ω (the highest). So enter the setting value as 10 Ω.

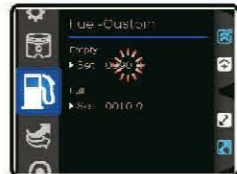

- EX : Set the lowest fuel level resistance value from 80 Ω to 90 Ω.
- Press the **Select** button twice to enter the highest fuel level resistance setting.



- Example : To set the highest fuel level resistance value as 10 Ω.
- Press the **Select** button to move to the digit you want to set.
- ⚠ Now the setting value is flashing!



- Press the **Adjust** button to choose the setting number.



- EX : Set the highest fuel level resistance value to 10 Ω.
- Press the **Select** button to go back to the fuel gauge resistance screen.



- Example : To set the lowest fuel level resistance value as 90 Ω.
- Press the **Select** button to move to the digit you want to set.
- ⚠ Now the setting value is flashing!

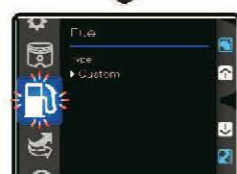

- Press the **Adjust** button to choose the setting number.

### 5-15-2 Fuel Gauge Resistance Setting (Auto Detection)



- Press the **Select** button to enter the fuel gauge resistance setting (auto detection).
- ⚠ **CAUTION!**
- Before detection, ensure that your current fuel level is in the lowest position that you would like to have.
- Stop the vehicle for a few seconds to allow the fuel surface to become steady, then start the detection of the resistance.

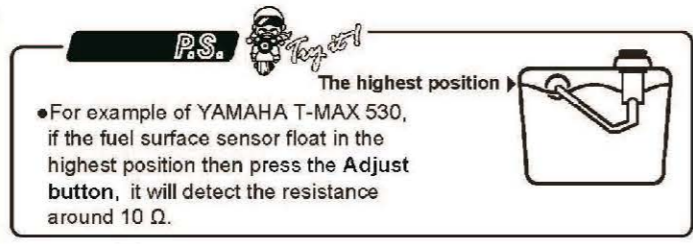

- For example of YAMAHA T-MAX 530, if the fuel surface sensor float in the highest position then press the **Adjust** button, it will detect the resistance around 10 Ω.



- For example of YAMAHA T-MAX 530, if the fuel surface sensor float in the lowest position then press the **Adjust** button, it will detect the resistance around 90 Ω.



- EX : Auto Detection the highest fuel level resistance value is 10 Ω.
- Press the **Select** button to go back to the fuel gauge resistance screen.



- The fuel gauge resistance screen.



- EX : Auto Detection the lowest fuel level resistance value is 90 Ω.
- Press the **Select** button 5 times to enter the highest fuel level resistance auto detection screen.

### 5-16 A/F Ratio Setting



- The A/F ratio screen, press the **Select** button for 3 seconds to enter the A/F ratio setting.

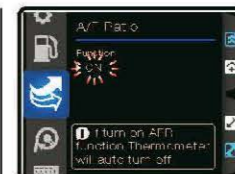

- Press the **Select** button to go back to the A/F ratio screen.



- Press the **Adjust** button, and select whether to turn on the A/F ratio warning function.
- ⚠ Now the setting value is flashing!
- NOTE Setting range : ON, OFF.  
Default value : OFF.
- ⚠ If turn on AFR function, Thermometer will auto turn off.



- The A/F ratio screen.

### 5-17 Power Test Setting



- The Power Test screen, press the **Select** button for 3 seconds to enter the Power Test setting.



- EX : Set target distance value from 50 m to 100 m.
- Press the **Select** button to enter the the record order setting.



- Example : To set target speed value to 110 km/h.
- Press the **Adjust** button to choose the setting number.
- ⚠ Now the setting value is flashing!
- NOTE Setting range : 30-360 km/h (20-225 MPH).  
Default value : 50 km/h (30 MPH).



- Example : To set record order to Best.
- Press the **Adjust** button to choose the setting options.
- ⚠ Now the setting value is flashing!
- NOTE Setting range : Sequence, Best.  
Default value : Sequence.



- EX : Set target speed value from 50 km/h to 110km/h.
- Press the **Select** button to enter the the target distance setting.



- EX : Set record order from Sequence to Best.
- Press the **Select** button to go back to the Power Test screen.



- Example : To set target distance value to 100 m.
- Press the **Adjust** button to choose the setting number.
- ⚠ Now the setting value is flashing!
- NOTE Setting range : 50~1,500 m (1/32~30/32 mile).  
Default value : 50 m (1/32 mile).



- The Power Test screen.

## 5-18 Internal and External ODO Setting



- The internal and external ODO screen, press the **Select** button for 3 seconds to enter the external ODO setting.
- ⚠ User unable to adjust or clear internal ODO.
- NOTE** Display range :0~999,999 km (mile).



- EX : Set external total distance value from 10,000 km to 12,500 km.
- Press the **Select** button to go back to the internal and external ODO screen.



- Example** : To set external total distance value to 12,500 km.
- Press the **Select** button to move to the digit you want to set.
- ⚠ Now the setting value is flashing!
- NOTE** Cursor's order : one hundred thousand→thousands→thousand→hundred→ten→digit.
- NOTE** Setting range : 0 ~ 999,999 km (mile).



- The internal and external ODO screen.



- Press the **Adjust** button to choose the setting number.

## 6 Trouble Shooting

The following situationS do not indicate malfunction of the meter. Please check the following before taking it in for repairs.

Trouble	Check item	Trouble	Check item
The meter doesn't work when the power is on.	<ul style="list-style-type: none"> <li>•The power isn't supplied to the meter.</li> <li>→Please make sure the wiring is connected. The wiring and fuse are not broken.</li> <li>→The battery is too old to supply needed power (DC 12 V).</li> </ul>	A/F ratio doesn't appear or appear incorrectly.	<ul style="list-style-type: none"> <li>•Check the setting.</li> <li>→Refer to the manual 5-16 A/F ratio setting.</li> </ul>
The meter shows wrong information. Speed meter doesn't appear or appears incorrectly.	<ul style="list-style-type: none"> <li>•Check the voltage of your battery, and make sure the voltage is over DC 12 V.</li> <li>•May be poor connection of the speed sensor.</li> <li>→Please check the speed sensor is connected correctly.</li> <li>•Check the setting.</li> <li>→Refer to the manual 5-12 circumference and sensing point setting.</li> </ul>	Fuel meter doesn't display or display error.	<ul style="list-style-type: none"> <li>•Check your fuel tank.</li> <li>•May be poor connection of the harness.</li> <li>→Please make sure the wires are connected correctly.</li> <li>•Check the setting.</li> <li>→Please check the settings menu, the fuel settings are correct.</li> </ul>
Tachometer doesn't appear or appears incorrectly.	<ul style="list-style-type: none"> <li>•Make sure the RPM wire is connected properly.</li> <li>→Check the RPM wire wire is connected correctly.</li> <li>•Please check the spark plug is R type or not. If not, please replace the spark plug with the R type spark plug.</li> <li>•Check the setting.</li> <li>→Refer to the manual 5-14 RPM input pulse, signal impulse.</li> </ul>	The clock is incorrect.	<ul style="list-style-type: none"> <li>•Check the setting.</li> <li>→Please check the settings menu, the clock settings are correct.</li> <li>•May be due to the reversed power line.</li> <li>→Please check the positive wire(Red) connects to the battery(DC 12 V), and main switch positive wiring(Brown) connects to the main switch(DC 12 V).</li> </ul>
Thermometer doesn't appear or appear incorrectly.	<ul style="list-style-type: none"> <li>•Make sure the temperature wire is connected properly.</li> <li>→Please check the temperature wire is connected correctly.</li> <li>•Check the setting.</li> <li>→Refer to the manual 5-6 overheat warning setting.</li> </ul>	The meter indicator didn't display.	<ul style="list-style-type: none"> <li>•May be poor connection of the harness.</li> <li>→Please make sure the wires are connected correctly.</li> </ul>

※ If you can't resolve the problems according to the steps above, please contact your local distributors.